

WIG/TIG Schweißbrenner

Welding torches / Torches de soudage

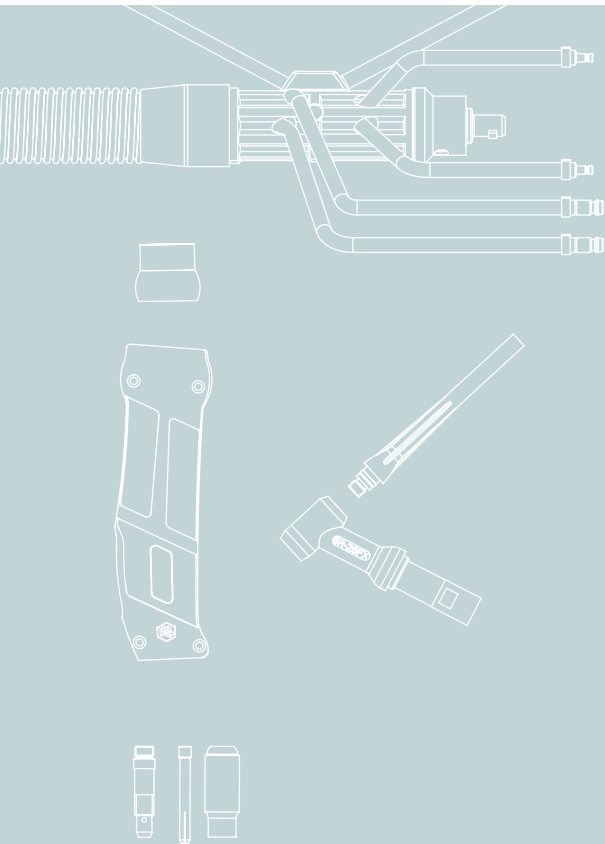

Luftgekühlt /
Air cooled /
Refroidissement par air



TBi SR 9 (FX) TBi SR 17 (FX) TBi SR 26 (FX) TBi SR 24G

	M12x1	Standard Standard, FX	415P09 0 413P09 0	415P17 0 413P17 0	415P26 0 413P26 0	415P23 0 -
	G 1/4"	Standard Standard, FX	415P09 2 413P09 2	415P17 2 413P17 2	415P26 2 413P26 2	415P23 2 -
	G 3/8"	Standard Standard, FX	415P09 3 413P09 3	415P17 3 413P17 3	415P26 3 413P26 3	415P23 3 -
	TSB 10/25 (Ø 9 mm)	Standard Standard, FX	415P09 3B 413P09 3B	415P17 3B 413P17 3B	415P26 3B 413P26 3B	415P23 3B -
	TSB 35/50 (Ø 13 mm)	Standard Standard, FX	415P09 3C 413P09 3C	415P17 3C 413P17 3C	415P26 3C 413P26 3C	415P23 3C -
	TSB 10/25 Mono (Ø 9 mm)	Standard Standard, FX	415P09 B 413P09 B	415P17 B 413P17 B	415P26 B 413P26 B	* -
	TSB 35/50 Mono (Ø 13 mm)	Standard Standard, FX	415P09 C 413P09 C	415P17 C 413P17 C	415P26 C 413P26 C	* -
	Euro-WTG-5	Standard Standard, FX	415P09 Y 413P09 Y	415P17 Y 413P17 Y	415P26 Y 413P26 Y	415P23 Y -
	Euro-GZ	Standard Standard, FX	415P09 9 413P09 9	415P17 9 413P17 9	415P26 8 413P26 8	415P23 9 -

Alle gängigen Maschinenanschlüsse ab Lager lieferbar, z.B. Esab®, SAF-Oerlikon®, Kemppi®, Lorch®, etc. Weitere Informationen auf Anfrage./

Torch connections for all types of power sources are on stock, e.g. for Esab®, SAF-Oerlikon®, Kemppi®, Lorch®, etc. More information on request. /

Tous types de raccords courants disponibles, par ex. : Esab®, SAF-Oerlikon®, Kemppi®, Lorch®, etc. Informations complémentaires sur demande.

Bitte gewünschtes Schaltermodul angeben /
Please indicate the required switch module /
Merci d'indiquer le module de commande souhaité

C

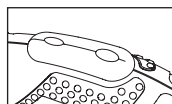

Doppeltaster /
Double function switch /
Double bouton

P

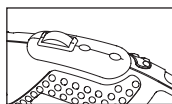

Doppeltaster mit Poti, 10 kΩ /
Double function switch with poti, 10 kΩ /
Double bouton et potentiomètre, 10 kΩ

D

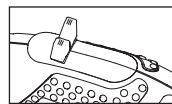

Doppelhebel /
Dual levers /
Double levier

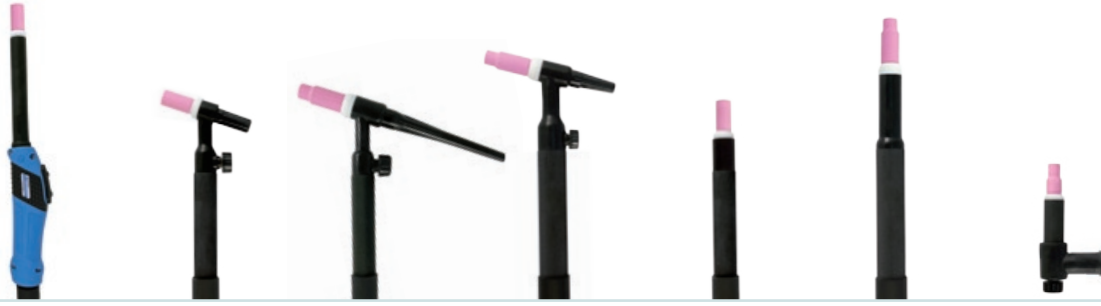

TBi SR 25G FX	TBi SR 9 V (FX)	TBi SR 17 V (FX)	TBi SR 26 V (FX)	TBi SR 9P (Aut)	TBi SR 26P (Aut)	TBi Aut 22G
- 413P25 0	405P09V 0 403P09V 0	405P17V 0 403P17V 0	405P26V 0 403P26V 0	491P097 0 -	491P267 0 -	491P237 0 -
- 413P25 2	405P09V 2 403P09V 2	405P17V 2 403P17V 2	405P26V 2 403P26V 2	491P097 0 -	491P267 2 -	491P237 2 -
- 413P25 3	405P09V 3 403P09V 3	405P17V 3 403P17V 3	405P26V 3 403P26V 3	491P097 0 -	491P267 3 -	491P237 3 -
- 413P25 3B	405P09V3B 403P09V3B	405P17V3B 403P17V3B	405P26V3B 403P26V3B	491P0973B -	- -	491P2373B -
- 413P25 3C	405P09V3C 403P09V3C	405P17V3C 403P17V3C	405P26V3C 403P26V3C	491P0973C -	491P2673C -	491P2373C -
- *	* *	* *	* *	* -	* -	491P237 B -
- *	* *	* *	* *	* -	* -	491P237 C -
- 413P25 Y	* *	* *	* *	* -	* -	* -
- 413P25 9	* *	* *	* *	491P09709 -	491P26708 -	* -

Bitte gewünschtes Schlauchpaket angeben /
Please indicate the required cable type /
Merci d'indiquer le type de faisceau souhaité

1 Gummiüberzugschlauch (Standard) /
Rubber outer cover (standard) /
Enveloppe faisceau en caoutchouc (standard)

L Lederüberzugschlauch vorne (ca. 0.6 m), Gummi /
Leather cover in the front (0.6 m), rubber cover /
Enveloppe cuir à l'avant (env. 0,6 m), reste caoutchouc

T Textilüberzugschlauch /
Textile outer cover /
Enveloppe textile

Bitte gewünschte Schlauchpaketlänge angeben /
Please indicate the required cable length /
Merci d'indiquer la longueur de faisceau souhaitée

4 4 m / 12 ft

8 8 m / 25 ft

* Artikelnummer auf Anfrage /
* Part-No. on request /
* Référence des pièces sur demande

Wassergekühlt / Water cooled / Refroidissement par eau



TBi SR 18 (FX) TBi SR 20 (FX) TBi SR 21 TBi SR 24W (FX)

			415P18	413P18	415P20	413P20	415P21	415P24	413P24
	M12x1	Standard	0	0	0	0	0	0	0
		Standard, FX	0	0	0	0	-	0	0
	G 1/4"	Standard	2	2	2	2	2	2	2
		Standard, FX	2	2	2	2	-	2	2
	G 3/8"	Standard	3	3	3	3	3	3	3
		Standard, FX	3	3	3	3	-	3	3
	TSB 35/50 (Ø 13 mm)	Standard	C	C	C	C	C	C	C
		Standard, FX	C	C	C	C	-	C	C
	Euro-WTW-5	Standard	Y	Y	Y	Y	Y	Y	Y
		Standard, FX	Y	Y	Y	Y	-	Y	Y
	Euro-WZ-O	Standard	5	5	5	5	5	5	5
		Standard, FX	5	5	5	5	-	5	5

Alle gängigen Maschinenanschlüsse ab Lager lieferbar, z.B. Esab®, SAF-Oerlikon®, Kemppi®, Lorch®, etc. Weitere Informationen auf Anfrage./

Torch connections for all types of power sources are on stock, e.g. for Esab®, SAF-Oerlikon®, Kemppi®, Lorch®, etc. More information on request. /

Tous types de raccords courants disponibles, par ex. : Esab®, SAF-Oerlikon®, Kemppi®, Lorch®, etc. Informations complémentaires sur demande.

Bitte gewünschtes Schaltermodul angeben /
Please indicate the required switch module /
Merci d'indiquer le module de commande souhaité

C

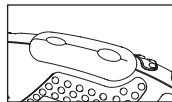

Doppeltaster /
Double function switch /
Double bouton

P

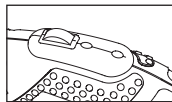

Doppeltaster mit Poti, 10 kΩ /
Double function switch with poti, 10 kΩ /
Double bouton et potentiomètre, 10 kΩ

D

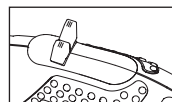

Doppelhebel /
Dual levers /
Double levier



TBi SR 25W FX TBi AW 424 TBi AW 427 TBi SR 400 TBi SR 12 TBi SR 18 V (FX) TBi SR 20 V (FX)

- 401P25 0	414P24 0 -	404P27 0 -	415P40 0 -	405P12R 0 -	405P18V 0 403P18V 0	405P20V 0 403P20V 0
- 401P25 2	414P24 2 -	404P27 2 -	415P40 2 -	405P12R12 -	405P18V 2 403P18V 2	405P20V 2 403P20V 2
- 401P25 3	414P24 3 -	404P27 3 -	415P40 3 -	405P12R13 -	405P18V 3 403P18V 3	405P20V 3 403P20V 3
- 401P25 C	414P24 C -	404P27 C -	415P40 C -	405P12R1C -	405P18V C 403P18V C	405P20V C 403P20V C
- 401P25 Y	414P24 Y -	404P27 Y -	415P40 Y -	405P12R1Y -	405P18V Y 403P18V Y	405P20V Y 403P20V Y
- 401P25 5	414P24 5 -	404P27 5 -	415P40 5 -	405P12R15 -	405P18V 5 403P18V 5	405P20V 5 403P20V 5

**Bitte gewünschtes Schlauchpaket angeben /
Please indicate the required cable type /
Merci d'indiquer le type de faisceau souhaité**

1 Gummiüberzugschlauch (Standard) /
Rubber outer cover (standard) /
Enveloppe faisceau en caoutchouc (standard)

L Lederüberzugschlauch vorne (ca. 0.6 m), Gummi /
Leather cover in the front (0.6 m), rubber cover /
Enveloppe cuir à l'avant (env. 0,6 m), reste caoutchouc

T Textilüberzugschlauch /
Textile outer cover /
Enveloppe textile

**Bitte gewünschte Schlauchpaketlänge angeben /
Please indicate the required cable length /
Merci d'indiquer la longueur de faisceau souhaitée**

4 4 m / 12 ft

8 8 m / 25 ft

Wassergekühlt / Water cooled / Refroidissement par eau



			TBi SR 18P (Aut)	TBi SR 20P (Aut)	TBi Aut 22W
	M12x1	Standard	491P187 0	491P207 0	491P227 0
	G 1/4"	Standard	491P187 2	491P207 2	491P227 2
	G 3/8"	Standard	491P187 3	491P207 3	491P227 3
	TSB 35/50 (Ø 13 mm)	Standard	491P187 C	491P207 C	491P227 C
	WTW-5	Standard	491P187 Y	491P207 Y	491P227 Y
	WZ-0	Standard	491P187 5	491P207 5	491P227 5

Bitte gewünschtes Schlauchpaket angeben /
Please indicate the required cable type /
Merci d'indiquer le type de faisceau souhaité

1

Gummiüberzugschlauch (Standard) /
Rubber outer cover (standard) /
Enveloppe faisceau en caoutchouc (std)

L

Lederüberzugschlauch vorne (ca. 0.6 m), Gummi /
Leather cover in the front (0.6 m), rubber cover /
Enveloppe cuir à l'avant (env. 0,6 m), reste caoutchouc

T

Textilüberzugschlauch /
Textile outer cover /
Enveloppe textile

Bitte gewünschte Schlauchpaketlänge angeben /
Please indicate the required cable length /
Merci d'indiquer la longueur de faisceau souhaitée

4

4 m / 12 ft

8

8 m / 25 ft

Alle gängigen Maschinenanschlüsse ab Lager lieferbar, z.B. Esab®, SAF-Oerlikon®, Kemppi®, Lorch®, etc. Weitere Informationen auf Anfrage./

Torch connections for all types of power sources are on stock, e.g. for Esab®, SAF-Oerlikon®, Kemppi®, Lorch®, etc. More information on request. /

Tous types de raccords courants disponibles, par ex. : Esab®, SAF-Oerlikon®, Kemppi®, Lorch®, etc. Informations complémentaires sur demande.

Ausführung mit Lamellenschalter / Models with blade switch / Modèles à lamelle

Luftgekühlt / Air cooled / Refroidissement par air

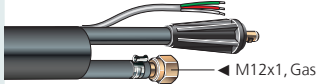
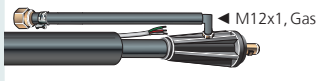

			TBi SR 9 (FX)	TBi SR 17 (FX)	TBi SR 26 (FX)	TBi SR 24G
	TSB 35/50 (Ø 13 mm)	Standard Standard, FX	405P917 1 403P917 1	405P917 2 403P917 2	405P917 5 403P917 5	405P917 7 -
	TSB 35/50 Mono (Ø 13 mm)	Standard Standard, FX	405P91761 403P91761	405P91762 403P91762	405P91765 403P91765	405P91767 -

Wassergekühlt / Water cooled / Refroidissement par eau

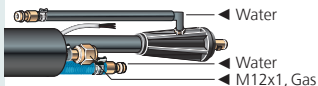

			TBi SR 18 (FX)	TBi SR 20 (FX)	TBi SR 21 (FX)	TBi SR 400	TBi SR 24W (FX)
	TSB 35/50 (Ø 13 mm)	Standard Standard, FX	405P917 3 403P917 3	405P917 4 403P917 4	405P917 9 403P917 9	405P917 8 -	405P917 6 403P917 6

Bitte gewünschtes Schlauchpaket angeben /
Please indicate the required cable type /
Merci d'indiquer le type de faisceau souhaité

- 5** Gummiüberzugschlauch (Standard) /
Rubber outer cover (standard) /
Enveloppe faisceau en caoutchouc (standard)
- L** Lederüberzugschlauch vorne (ca. 0.6 m), Gummi /
Leather cover in the front (approx. 0.6 m), rubber /
Enveloppe cuir à l'avant (env. 0,6m), reste caoutchouc
- T** Textilüberzugschlauch /
Textile outer cover /
Enveloppe textile

Bitte gewünschte Schlauchpaketlänge angeben /
Please indicate the required cable length /
Merci d'indiquer la longueur de faisceau souhaitée

- 4** 4 m / 12 ft
- 8** 8 m / 25 ft

Weitere Modelle auf Anfrage verfügbar /
Other models available on request /
Autres modèles disponibles sur demande

TBi SR 25G,
TBi SR 25W,
TBi SR 12,
TBi AW 424,
TBi AW 428

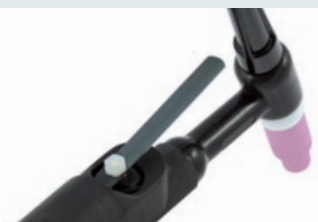

Hinweis / Note / Avis

Bitte beachten Sie bei den Modellen TBi SR 18, TBi SR 26 und TBi SR 400, dass sich der Brennerkörper von der Version mit Precision-Griff unterscheidet /
Please note that the torch body for models TBi SR 18, TBi SR 26 and TBi SR 400 is different from the torch body for the Precision handle /
Merci de prendre en compte que le corps de torche des modèles TBi SR 18, TBi SR 26 et TBi SR 400, se différencie du corps de torche de la version à poignée Précision.

TBi SR 9 , TBi SR 20 , TBi SR 21



TBi SR 9 (FX)
 luftgekühlt /
 air cooled / refroidissement par air
 60% (10 min.)
 AC: 95 A
 DC: 110 A
 Ø 0.5-1.6 mm



TBi SR 20 (FX)
 wassergekühlt /
 water cooled / refroidissement par eau
 100% (10 min.)
 AC: 200 A
 DC: 220 A
 Ø 0.5-3.2 mm



TBi SR 21
 wassergekühlt /
 water cooled / refroidissement par eau
 100% (10 min.)
 AC: 260 A
 DC: 340 A
 Ø 0.5-3.2 mm

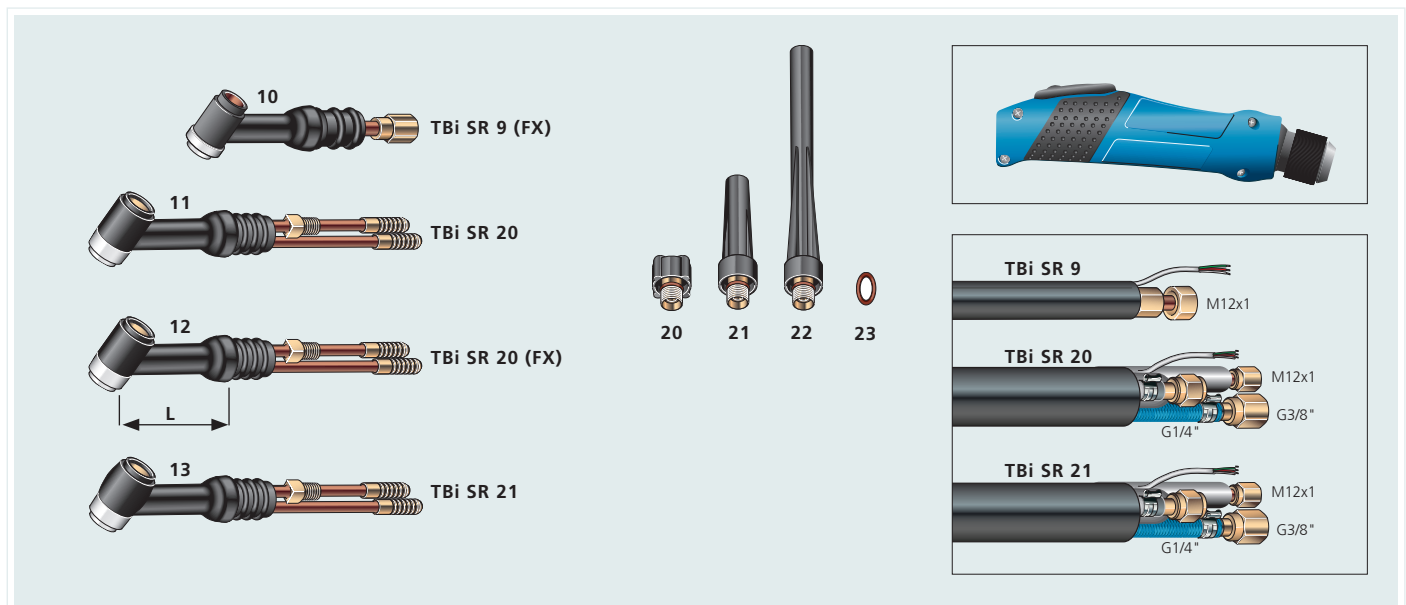

Ersatzteile / Spare parts / Pièces de rechange

10	SR 9	Brennerkörper / torch body / corps de torche		405P090800
10	SR 9 FX	Brennerkörper / torch body / corps de torche	flexible	403P090800
11	SR 20	Brennerkörper / torch body / corps de torche		405P200800
12	SR 20 FX	Brennerkörper / torch body / corps de torche	flexible, L=50 mm	403P200700
12	SR 20 FX-L	Brennerkörper / torch body / corps de torche	flexible, L=75 mm	403P200850
12	SR 20 FX-LL	Brennerkörper / torch body / corps de torche	flexible, L=100 mm	403P200750
12	SR 20 FX-XL	Brennerkörper / torch body / corps de torche	flexible, L=125 mm	403P200800
13	SR 21	Brennerkörper / torch body / corps de torche		405P210800
20	Brennerkappe / Back cap / Coiffe	kurz / short / courte	L=18.0 mm	41V33 401P200100
21	Brennerkappe / Back cap / Coiffe	mittel / medium / moyenne	L=53.2 mm	41V35 401P200200
22	Brennerkappe / Back cap / Coiffe	lang / long / longue	L=147.5 mm	41V24 401P200300
23	O-Ring / O-Ring / Joint torique			98W77 365P200046

Verschleißteile 9 / Consumables / Consommables

▶ A	Isolator / Insulator / Isolateur	Standard	598882	402P200900
B	Adapter / Adapter / Adaptateur	Jumbo Gas lens	54N63-20	401P200905

▶ = Standard

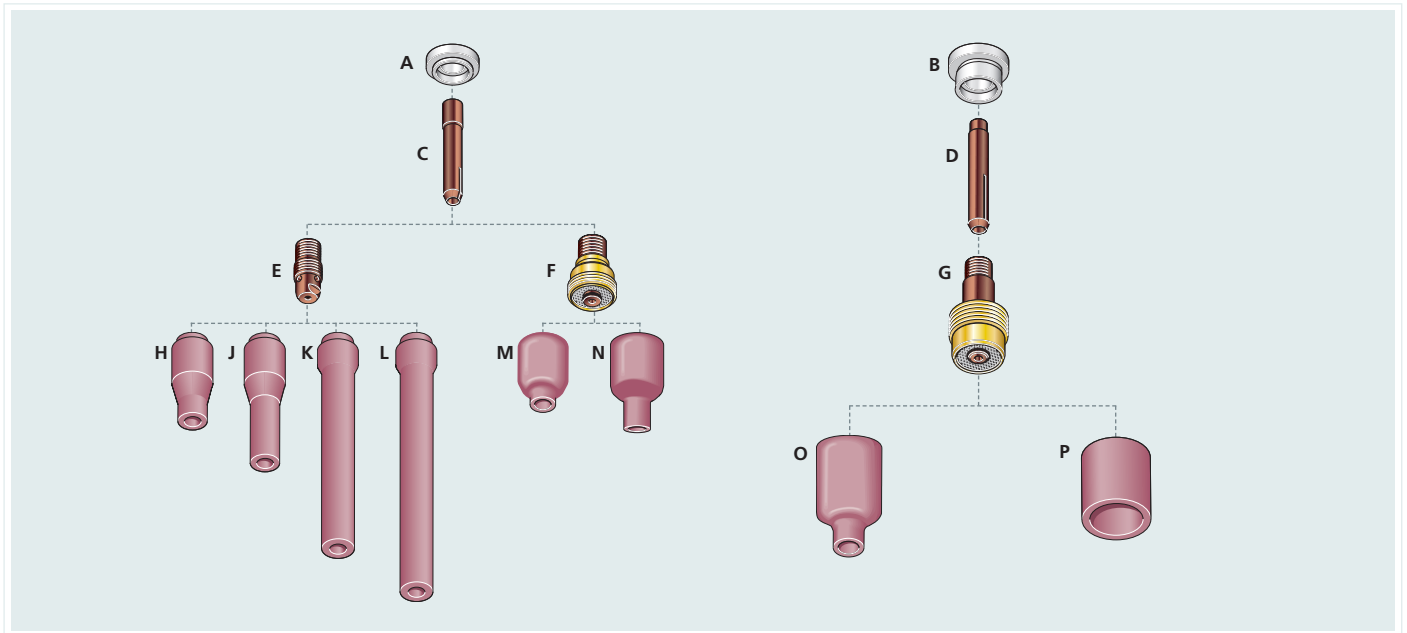

		Ø 0.5 mm Ø 0.020"	Ø 1.0 mm Ø 0.040"	Ø 1.6 mm Ø 1/16"	Ø 2.0 mm	Ø 2.4 mm Ø 3/32"	Ø 3.0 mm	Ø 3.2 mm Ø 1/8"
Spannhülsen / Collets / Pincés etau								
▶ C	Standard, L=25.4 mm	13N20 401P200599	13N21 401P200600	13N22 401P200601	- 401P200604	13N23 401P200602	- 401P200605	13N24 401P201603
D	Jumbo, L=40.1 mm	-	13N21L 401P13N21L	13N22L 401P13N22L	-	13N23L 401P13N23L	-	13N24L 401P13N24L
Spannhülsegehäuse / Collet bodies / Supports collets								
▶ E	L=20.6 mm	13N25 401P200999	13N26 401P201000	13N27 401P201001	- 401P201005	13N28 401P201002	- 401P201006	13N29 401P201003
Gaslinsen / Gas lenses / Diffuseurs gaz								
F	Standard, L=21.5 mm	-	45V42 401P201300	45V43 401P201301	- 401P201304	45V44 401P201302	- 401P201305	45V45 401P201303
G	Jumbo, L=41.5 mm	-	45V0204S 401P201350	45V116S 401P201351	-	45V64S 401P201352	-	995795S 401P201353

		No. 3 Ø 5.0 mm Ø 3/16"	No. 4 Ø 6.5 mm Ø 1/4"	No. 5 Ø 8.0 mm Ø 5/16"	No. 6 Ø 9.5 mm Ø 3/8"	No. 7 Ø 11 mm Ø 7/16"	No. 8 Ø 12.5 mm Ø 1/2"	No. 10 Ø 16 mm Ø 5/8"
Keramische Gasdüsen / Ceramic nozzles / Buses gaz								
▶ H	Standard, L=30.0 mm	-	13N08 401P201106	13N09 401P201107	13N10 401P201108	13N11 401P201109	13N12 401P201110	13N13 401P201111
J	Standard, L, L=48.0 mm	796F70 401P201115	796F71 401P201116	796F72 401P201117	796F73 401P201118	-	-	-
K	Standard, XL, L=63.0 mm	-	796F75 401P201126	796F76 401P201127	796F77 401P201128	-	-	-
L	Standard, XXL, L=89.0 mm	-	796F79 401P201136	-	-	-	-	-

		No. 4 Ø 6.5 mm Ø 1/4"	No. 5 Ø 8.0 mm Ø 5/16"	No. 6 Ø 9.5 mm Ø 3/8"	No. 7 Ø 11 mm Ø 7/16"	No. 8 Ø 12.5 mm Ø 1/2"	No. 10 Ø 16 mm Ø 5/8"	No. 12 Ø 19 mm Ø 3/4"	Ø 24 mm
Keramische Gasdüsen / Ceramic nozzles / Buses gaz									
M	Gas lens, L=25.5 mm	53N58 401P201400	53N59 401P201401	53N60 401P201402	53N61 401P201403	53N61S 401P201404	-	-	-
N	Gas lens, L, L=35.0 mm	-	53N59L 401P201405	53N60L 401P201406	-	-	-	-	
O	Jumbo Gas lens L=48.0 mm	-	-	57N75 401P201451	-	57N74 401P201452	53N88 401P222250	53N87 401P222251	53N89-L 401P222253
P	Jumbo Gas lens (short), L=34.0 mm	-	-	-	-	-	-	-	53N89 401P222252

▶ = Standard

TBi SR 17 , TBi SR 18 , TBi SR 26



TBi SR 17 (FX)
 luftgekühlt /
 air cooled / refroidissement par air
 60% (10 min.)
 AC: 125 A
 DC: 140 A
 Ø 0.5-2.4 mm



TBi SR 18 (FX)
 wassergekühlt /
 water cooled / refroidissement par eau
 100% (10 min.)
 AC: 240 A
 DC: 320 A
 Ø 0.5-4.0 mm



TBi SR 26 (FX)
 luftgekühlt /
 air cooled / refroidissement par air
 60% (10 min.)
 AC: 200 A
 DC: 240 A
 Ø 0.5-4.0 mm

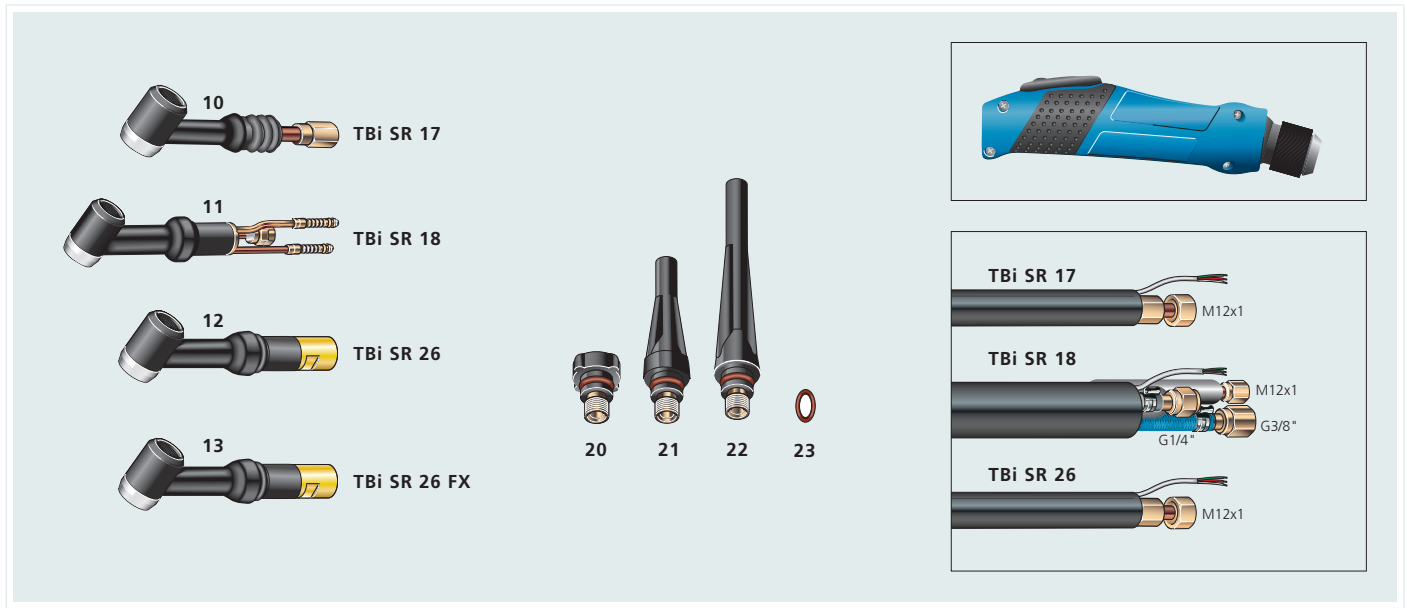

Ersatzteile / Spare parts / Pièces de rechange

10	SR 17	Brennerkörper / torch body / corps de torche		405P170700
10	SR 17 FX	Brennerkörper / torch body / corps de torche	flexible	403P170700
11	SR 18	Brennerkörper / torch body / corps de torche		405P180702
11	SR 18 FX	Brennerkörper / torch body / corps de torche	flexible	403P180702
12	SR 26	Brennerkörper / torch body / corps de torche		405P260702
13	SR 26 FX	Brennerkörper / torch body / corps de torche	flexible	403P260702
20	Brennerkappe / Back cap / Coiffe	kurz / short / courte	L=25.0 mm	57Y04 402P170100
21	Brennerkappe / Back cap / Coiffe	mittel / medium / moyenne	L=60.0 mm	57Y05 402P170150
22	Brennerkappe / Back cap / Coiffe	lang / long / longue	L=138.0 mm	57Y02 402P170200
23	O-Ring / O-Ring / Joint torique			98W18 365P200096

Verschleißteile / Consumables / Consommables

A	Isolator / Insulator / Isolateur	small	18CG20	402P18CG20
B	Isolator / Insulator / Isolateur	small, Gas lens		402P956100
▶ C	Isolator / Insulator / Isolateur	standard	18CG	403P171000
D	Isolator / Insulator / Isolateur	Gas lens	54N01	401P181100
E	Adapter / Adapter / Adaptateur	Jumbo Gas lens	54N63	401P171105

▶ = Standard

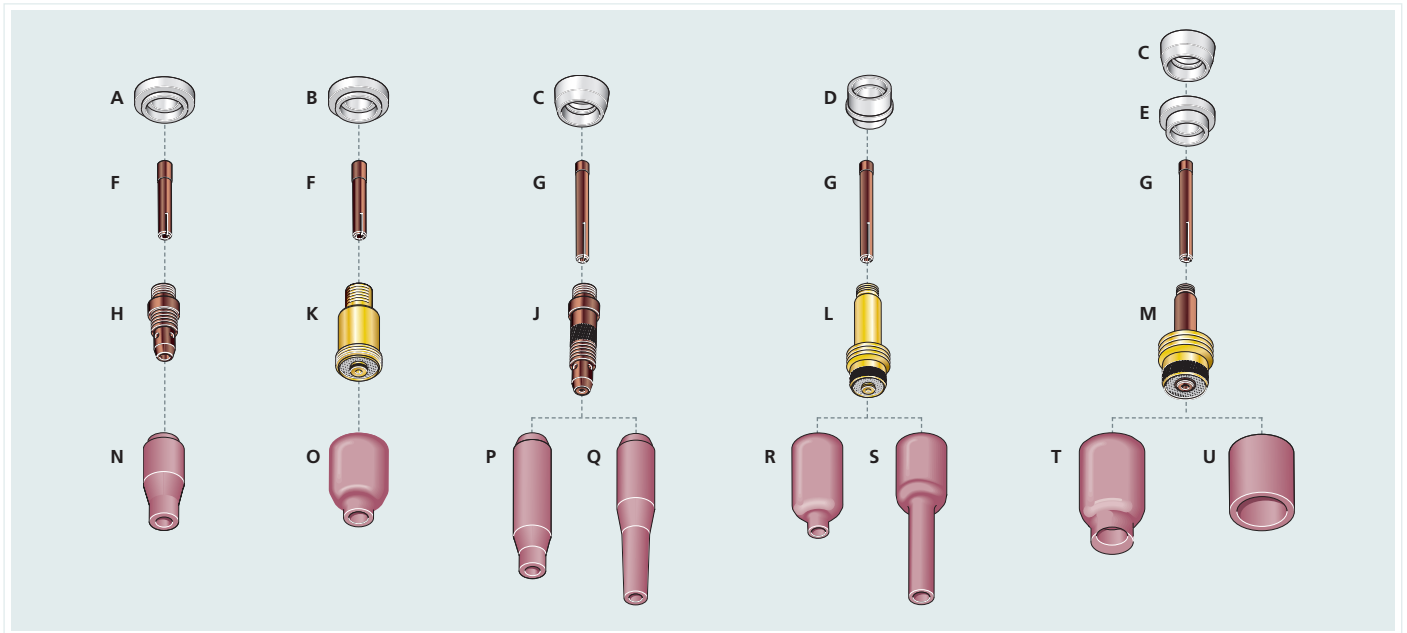

	Ø 0.5 mm Ø 0.020"	Ø 1.0 mm Ø 0.040"	Ø 1.6 mm Ø 1/16"	Ø 2.0 mm	Ø 2.4 mm Ø 3/32"	Ø 3.0 mm	Ø 3.2 mm Ø 1/8"	Ø 4.0 mm Ø 5/32"
--	----------------------	----------------------	---------------------	----------	---------------------	----------	--------------------	---------------------

Spannhülsen / Collets / Pincas etau

F	kurz / short / court L=29.3 mm	-	10N22S 402P10N23S	10N22S 402P10N23S	-	10N24S 402P10N24S	-	10N25S 402P10N25S	-
▶ G	Standard L=50.0 mm	10N21 402P170499	10N22 402P170500	10N23 402P170502	402P170506	10N24 402P170503	402P170507	10N25 402P170504	54N20 402P170505

Spannhülsegehäuse / Collet bodies / Supports collets

H	kurz / short / court L=24.5 mm	-	17CB21 402P17CB21	17CB22 402P17CB22	-	17CB23 402P17CB23	-	17CB24 402P17CB24	-
▶ J	Standard L=47.0 mm	10N29 401P180997	10N30 401P180998	10N31 401P180999	401P181003	10N32 401P181000	401P181004	10N28 401P181001	406488 401P181002

Gaslinsen / Gas lenses / Diffuseurs gaz

K	kurz / short / court L=21.5 mm	-	402P956048	402P956049	-	402P956050	-	402P956051	-
L	Standard L=48.5 mm	-	45V24 401P181299	45V25 401P181300	401P181304	45V26 401P181301	401P181305	45V27 401P181302	45V28 401P181303
M	Jumbo L=50.0 mm	-	45V0204 401P181350	45V116 401P181351	-	45V64 401P181352	-	995795 401P181353	45V63 401P181354

	No. 4 Ø 6.5 mm Ø 1/4"	No. 5 Ø 8.0 mm Ø 5/16"	No. 6 Ø 9.5 mm Ø 3/8"	No. 7 Ø 11 mm Ø 7/16"	No. 8 Ø 12.5 mm Ø 1/2"	No. 10 Ø 16 mm Ø 5/8"	No. 12 Ø 19 mm Ø 3/4"	Ø 24.0 mm
--	-----------------------------	------------------------------	-----------------------------	-----------------------------	------------------------------	-----------------------------	-----------------------------	-----------

Keramische Gasdüsen / Ceramic nozzles / Buses gaz

N	kurz / short / court L=30.0 mm	13N08 401P201106	13N09 401P201107	13N10 401P201108	13N11 401P201109	13N12 401P201110	13N13 401P201111	-	-
O	Gas lens short L=25.5 mm	53N58 401P201400	53N59 401P201401	53N60 401P201402	53N61 401P201403	53N61S 401P201404	-	-	-
▶ P	Standard L=47.0 mm	10N50 401P170907	10N49 401P170908	10N48 401P170909	10N47 401P170910	10N46 401P170911	10N45 401P170912	10N44 401P170913*	-
Q	Standard, L L=76.0 mm	10N50L 401P170923	10N49L 401P170914	10N48L 401P170915	10N47L 401P170916	-	-	-	-
R	Gas lens L=42.0 mm	54N18 401P222200	54N17 401P222201	54N16 401P222202	54N15 401P222203	54N14 401P222204	-	54N19 401P222206	-
S	Gas lens, L L=76.0 mm	54N18 L 401P222211	54N17 L 401P222207	54N16 L 401P222208	54N15 L 401P222209	54N14 L 401P222210	-	-	-
T	Jumbo Gas lens L=48.0 mm	-	-	57N75 401P201451	-	57N74 401P201452	53N88 401P222250	53N87 401P222251	53N89-L 401P222253
U	Jumbo Gas lens (short), L=34.0 mm	-	-	-	-	-	-	-	53N89 401P222252

* L=50.0 mm

▶ = Standard

TBi SR 24G , TBi SR 24W



TBi SR 24G

luftgekühlt /
air cooled / refroidisse-
ment par air

60% (10 min.)
AC: 95 A
DC: 110 A
Ø 0.5-1.6 mm

TBi SR 24W (FX)

wassergekühlt /
water cooled / refroi-
dissement par eau

100% (10 min.)
AC: 125 A
DC: 140 A
Ø 0.5-2.4 mm

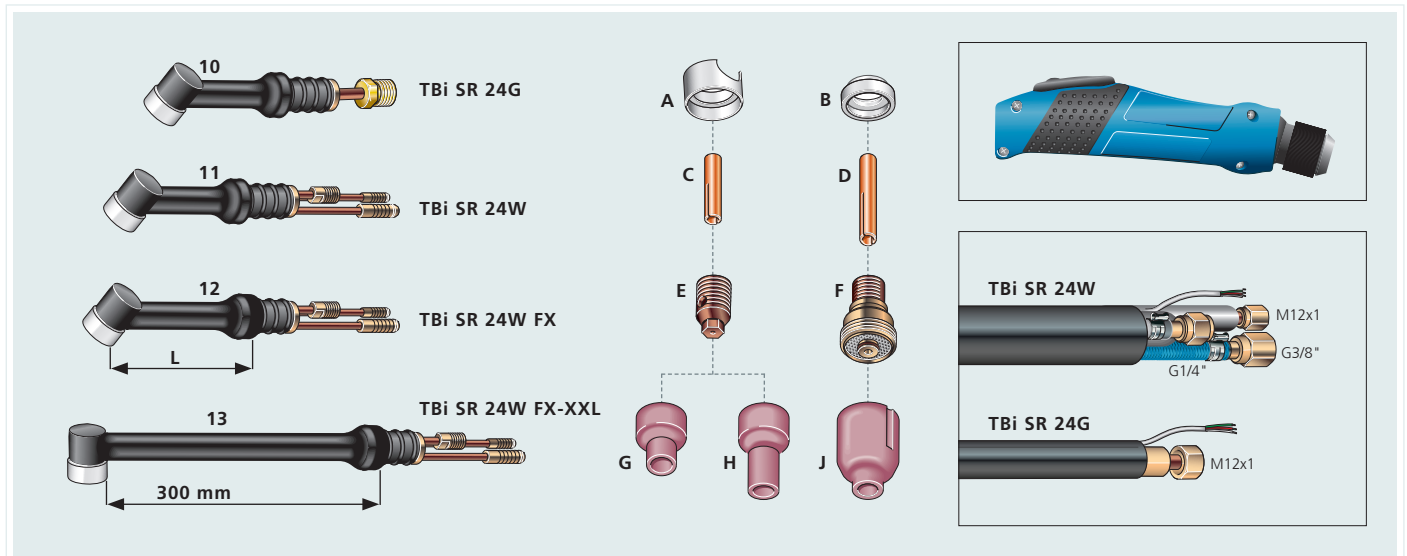

Ersatzteile / Spare parts / Pièces de rechange

10	SR 24G	Brennerkörper / torch body / corps de torche			405P240800
11	SR 24W	Brennerkörper / torch body / corps de torche			405P240850
12	SR 24W FX	Brennerkörper / torch body / corps de torche	flexible, L=75 mm	Standard	403P240700
12	SR 24W FX-L	Brennerkörper / torch body / corps de torche	flexible, L=100 mm		403P240750
12	SR 24W FX-XL	Brennerkörper / torch body / corps de torche	flexible, L=125 mm		403P240701
13	SR 24W FX-XXL	Brennerkörper / torch body / corps de torche	flexible, L=300 mm		403P240770
▶ A	Isolator / Insulator / Isolateur				53N22 401P240700
B	Isolator / Insulator / Isolateur		Gas lens		53N66 401P240701

	Ø 0.5 mm Ø 0.020"	Ø 1.0 mm Ø 0.040"	Ø 1.6 mm Ø 1/16"	Ø 2.4 mm Ø 3/32"
--	----------------------	----------------------	---------------------	---------------------

Spannhülse / Collet / Pince etau

▶ C	L=14.0 mm	53N15 401P240500	53N16 401P240501	53N14 401P240502	24C332 401P240505
D	Gas lens, L=23.0 mm	-	53N63 401P240802	53N64 401P240803	24GLC332 401P240805

Spannhülsegehäuse / Collet body / Support collet

▶ E	L=12.0 mm	53N17 401P241000	53N18 401P241001	53N19 401P241002	24CB332 401P241003
-----	-----------	---------------------	---------------------	---------------------	-----------------------

Gaslinsen / Gas lens / Diffuseur gaz

F	L=21.5 mm	-	45V42 401P201300	45V43 401P201301	45V44 401P201302
---	-----------	---	---------------------	---------------------	---------------------

	No. 4 Ø 6.5 mm Ø 1/4"	No. 5 Ø 8.0 mm Ø 5/16"	No. 6 Ø 9.5 mm Ø 3/8"	No. 7 Ø 11 mm Ø 7/16"	No. 8 Ø 12.5 mm Ø 1/2"
--	-----------------------------	------------------------------	-----------------------------	-----------------------------	------------------------------

Keramische Gasdüsen / Ceramic nozzles / Buses gaz

▶ G	Standard, L=16.5 mm	53N24 401P240900	53N25 401P240901	53N27 401P240902	-	-
H	Standard, lang / long / long L=29.0 mm	53N24L 401P240903	-	53N26L 401P240904	-	-
J	Gaslinse / Gas lens / Diffuseur gaz L=25.5 mm	53N58 401P201400	53N59 401P201401	53N60 401P201402	53N61 401P201403	53N61S 401P200404

▶ = Standard



TBi SR 25G FX / TBi SR 25W FX

TBi SR 25G FX

luftgekühlt /
air cooled / refroidissement par air
60% (10 min.)
AC: 95 A
DC: 110 A
Ø 0.5-2.4 mm

TBi SR 25W FX

wassergekühlt /
water cooled / refroidissement par eau
100% (10 min.)
AC: 125 A
DC: 140 A
Ø 0.5-3.2 mm

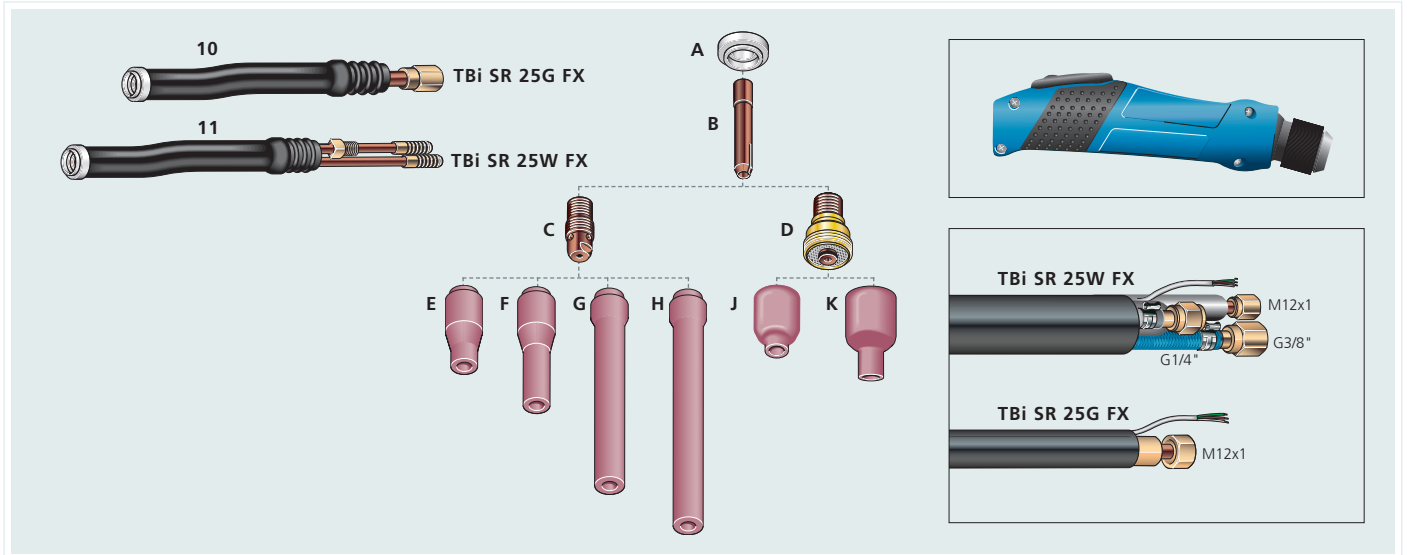

Ersatzteile / Spare parts / Pièces de rechange

10	SR 25G FX	Brennerkörper / torch body / corps de torche	flexible	401P250200
11	SR 25W FX	Brennerkörper / torch body / corps de torche	flexible	401P251200
A	Isolator / Insulator / Isolateur			598882-D 401P200950

	Ø 0.5 mm Ø 0.020"	Ø 1.0 mm Ø 0.040"	Ø 1.6 mm Ø 1/16"	Ø 2.0 mm	Ø 2.4 mm Ø 3/32"	Ø 3.0 mm	Ø 3.2 mm Ø 1/8"
--	----------------------	----------------------	---------------------	----------	---------------------	----------	--------------------

Spannhülse / Collet / Pince étou

▶ B	Standard, L=25.4 mm	13N20 401P200599	13N21 401P200600	13N22 401P200601	- 401P200604	13N23 401P200602	- 401P200605	13N24 401P200603
-----	---------------------	---------------------	---------------------	---------------------	-----------------	---------------------	-----------------	---------------------

Spannhülsegehäuse / Collet body / Support collet

▶ C	L=20.6 mm	13N25 401P200999	13N26 401P201000	13N27 401P201001	- 401P201005	13N28 401P201002	- 401P201006	13N29 401P201003
-----	-----------	---------------------	---------------------	---------------------	-----------------	---------------------	-----------------	---------------------

Gaslinsen / Gas lens / Diffuseur gaz

D	L=21.5 mm	-	45V42 401P201300	45V43 401P201301	- 401P201304	45V44 401P201302	- 401P201305	45V45 401P201303
---	-----------	---	---------------------	---------------------	-----------------	---------------------	-----------------	---------------------

	No. 3 Ø 5.0 mm Ø 3/16"	No. 4 Ø 6.5 mm Ø 1/4"	No. 5 Ø 8.0 mm Ø 5/16"	No. 6 Ø 9.5 mm Ø 3/8"	No. 7 Ø 11 mm Ø 7/16"	No. 8 Ø 12.5 mm Ø 1/2"	No. 10 Ø 16 mm Ø 5/8"
--	------------------------------	-----------------------------	------------------------------	-----------------------------	-----------------------------	------------------------------	-----------------------------

Keramische Gasdüsen / Ceramic nozzles / Buses gaz

▶ E	Standard, L=30.0 mm	-	13N08 401P201106	13N09 401P201107	13N10 401P201108	13N11 401P201109	13N12 401P201110	13N13 401P201111
F	Standard, L, L=48.0 mm	796F70 401P201115	796F71 401P201116	796F72 401P201117	796F73 401P201118	-	-	-
G	Standard, XL, L=63.0 mm	-	796F75 401P201126	796F76 401P201127	796F77 401P201128	-	-	-
H	Standard, XXL, L=89.0 mm	-	796F79 401P201136	-	-	-	-	-
J	Gas lens, L=25.5 mm	-	53N58 401P201400	53N59 401P201401	53N60 401P201402	53N61 401P201403	53N61S 401P201404	-
K	Gas lens, L, L=35.0 mm	-	-	53N59L 401P201405	53N60L 401P201406	-	-	-

▶ = Standard

TBi AW 424 , TBi AW 427



TBi AW 424
 wassergekühlt /
 water cooled / refroidissement par eau
 100% (10 min.)
 AC: 280 A
 DC: 400 A
 Ø 1.0-4.0 mm



TBi AW 427
 wassergekühlt /
 water cooled / refroidissement par eau
 100% (10 min.)
 AC: 350 A
 DC: 500 A
 Ø 2.0-8.0 mm

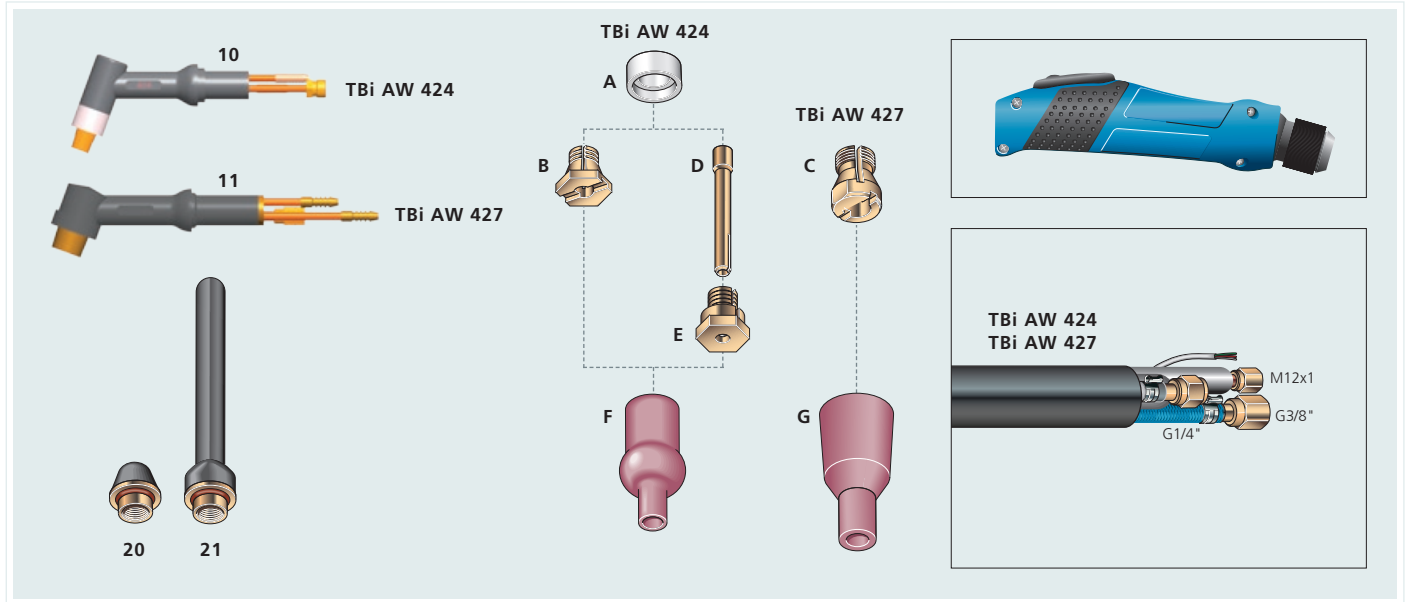

Ersatzteile / Spare parts / Pièces de rechange

10	AW 424	Brennerkörper / torch body / corps de torche						404P240702
11	AW 427	Brennerkörper / torch body / corps de torche						404P270702
20	Brennerkappe / Back cap / Coiffe	kurz / short / courte			L=20.5 mm		411-30	404P240100
21	Brennerkappe / Back cap / Coiffe	lang / long / longue			L=105.5 mm		411-70	404P240200
A	Isolator / Insulator / Isolateur				AW 424		200 NG	404P280300

	Ø 1.0 mm Ø 0.040"	Ø 1.6 mm Ø 1/16"	Ø 2.4 mm Ø 3/32"	Ø 3.2 mm Ø 1/8"	Ø 4.0 mm Ø 5/32"	Ø 4.8 mm Ø 3/16"	Ø 6.4 mm Ø 1/4"	Ø 8.0 mm Ø 5/16"
--	----------------------	---------------------	---------------------	--------------------	---------------------	---------------------	--------------------	---------------------

Spannzange / direct clamping collet / pince étau simple

B	AW 424, L=10.5 mm	-	221.00 404P240501	222.00 404P240502	223.00 404P240503	224.00 404P240504	-	-	-
C	AW 427, L=17 mm	Ø 2.0 mm 222-07, 404P270498		223-07 404P270499	224-07 404P270500	225-07 404P270501	226-07 404P270502	227-07 404P270503	228-07 404P270504

Spannhülse / collet / pince étau

D	AW 424, L=59 mm	964.01 404P240602	965.01 404P240603	966.01 404P240604	967.01 404P240605	968.01 404P240606	-	-	-
---	--------------------	----------------------	----------------------	----------------------	----------------------	----------------------	---	---	---

Spannhülsegehäuse / Collet body / Support collet

E	AW 424, L=10.5 mm	961.41 404P240902	961.51 404P240903	961.61 404P240904	961.71 404P240905	961.81 404P240906	-	-	-
---	----------------------	----------------------	----------------------	----------------------	----------------------	----------------------	---	---	---

	No. 4 Ø 6.5 mm Ø 1/4"	No. 5 Ø 8.0 mm Ø 5/16"	No. 6 Ø 9.5 mm Ø 3/8"	No. 7 Ø 11 mm Ø 7/16"	No. 8 Ø 12.5 mm Ø 1/2"	No. 9 Ø 14 mm Ø 9/16"	No. 10 Ø 16 mm Ø 5/8"	Ø 18 mm
--	-----------------------------	------------------------------	-----------------------------	-----------------------------	------------------------------	-----------------------------	-----------------------------	---------

Keramische Gasdüsen / Ceramic nozzles / Buses gaz

F	Standard, L=44.0 mm	130-00 404P241100	131-00 404P241101	132-00 404P241102	133-00 404P241103	134-00 404P241104	135-00 404P241105	136-00 404P241106	- 404P241108
G	Standard, L=54.0 mm	141-00 404P271100	142-00 404P271101	143-00 404P271102	144-00 404P271103	145-00 404P271104	-	-	-



TBi SR 400
 wassergekühlt /
 water cooled / refroidissement par eau
 100% (10 min.)
 AC: 400 A
 DC: 450 A
 Ø 1.0-4.8 mm

TBi SR 400

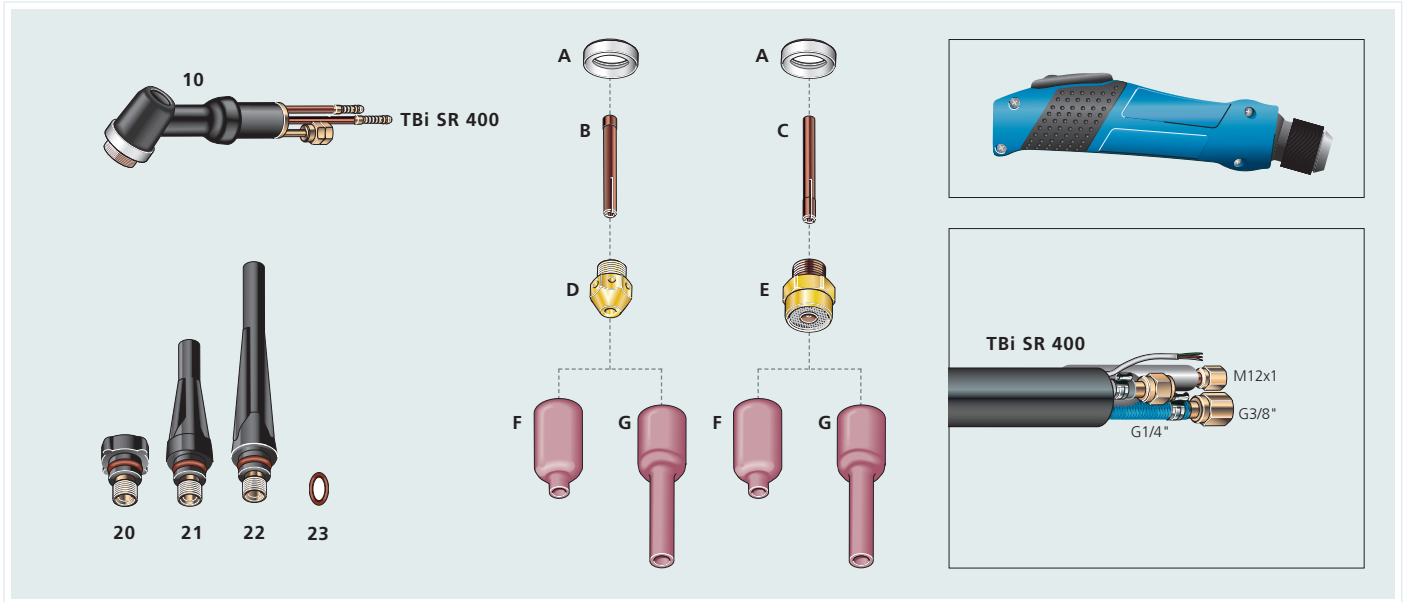

Ersatzteile / Spare parts / Pièces de rechange

10	SR 400	Brennerkörper / torch body / corps de torche				405P400802
20	Brennerkappe / Back cap / Coiffe	kurz / short / courte	L=25.0 mm	57Y04	402P170100	
21	Brennerkappe / Back cap / Coiffe	mittel / medium / moyenne	L=60.0 mm	57Y05	402P170150	
22	Brennerkappe / Back cap / Coiffe	lang / long / longue	L=138.0 mm	57Y02	402P170200	
23	O-Ring / O-Ring / Joint torique			98W18	365P200096	
A	Isolator / Insulator / Isolateur			18NG	405P400001	

	Ø 1.0 mm Ø 0.040"	Ø 1.6 mm Ø 1/16"	Ø 2.4 mm Ø 3/32"	Ø 3.2 mm Ø 1/8"	Ø 4.0 mm Ø 5/32"	Ø 4.8 mm Ø 3/16"
--	----------------------	---------------------	---------------------	--------------------	---------------------	---------------------

Spannhülse / Collet / Pince étou

▶ B	Standard, L=50 mm	10N22 402P170500	10N23 402P170502	10N24 402P170503	10N25 402P170504	54N20 402P170505	-
C	Heavy duty, L=50 mm	-	-	-	10N25HD 405P400504	54N20HD 405P400505	18C36 405P400506

Spannhülsegehäuse / Collet body / Support collet

▶ D	L=19.5 mm	Ø 1.0-3.2 mm 405P401000		Ø 3.2-4.8 mm 405P401001		
-----	-----------	----------------------------	--	----------------------------	--	--

Gaslinsen / Gas lens / Diffuseur gaz

E	L=21.3 mm	18GL04 405P401301	18GL16 405P401302	18GL32 405P401303	18GL18 405P401304	18GL53 405P401305	18GL36 405P401306
---	-----------	----------------------	----------------------	----------------------	----------------------	----------------------	----------------------

	No. 4 Ø 6.5 mm Ø 1/4"	No. 5 Ø 8.0 mm Ø 5/16"	No. 6 Ø 9.5 mm Ø 3/8"	No. 7 Ø 11 mm Ø 7/16"	No. 8 Ø 12.5 mm Ø 1/2"	No. 12 Ø 19 mm Ø 3/4"
--	-----------------------------	------------------------------	-----------------------------	-----------------------------	------------------------------	-----------------------------

Keramische Gasdüsen / Ceramic nozzles / Buses gaz

▶ F	Gas lens L=42.0 mm	54N18 401P222200	54N17 401P222201	54N16 401P222202	54N15 401P222203	54N14 401P222204	54N19 401P222206
G	Gas lens, L, L=76.0 mm	54N18 L 401P222211	54N17 L 401P222207	54N16 L 401P222208	54N15 L 401P222209	54N14 L 401P222210	-

▶ = Standard

TBi SR 12



TBi SR 12

wassergekühlt /
water cooled / refroidissement par eau

100% (10 min.)
AC: 450 A
DC: 500 A
Ø 2.4-6.4 mm

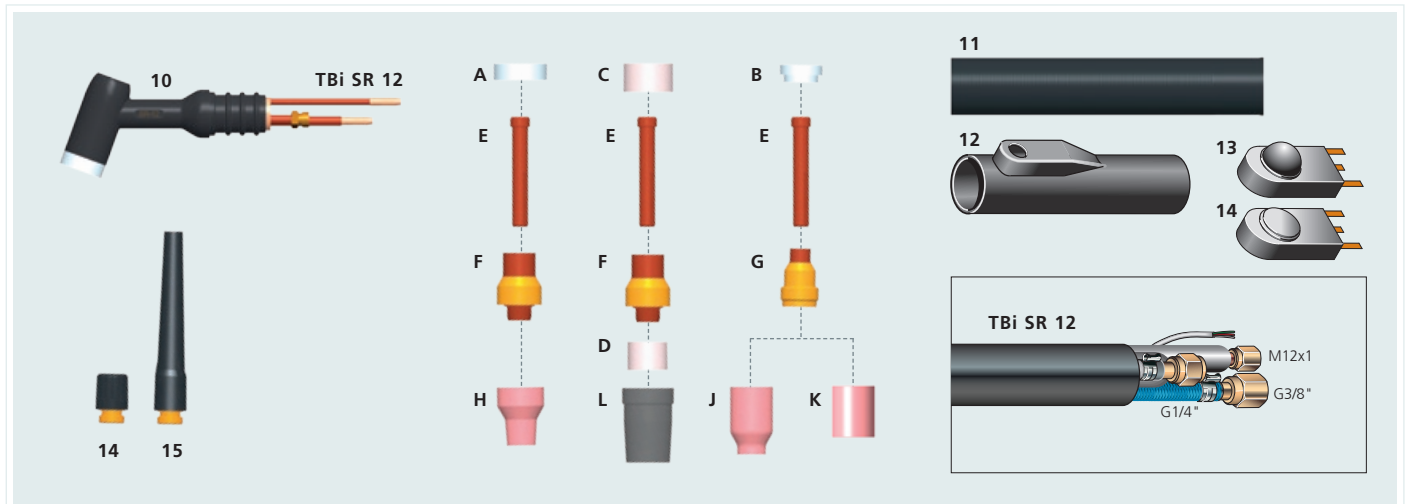

Ersatzteile / Spare parts / Pièces de rechange

10	SR 12	Brennerkörper / torch body / corps de torche						405P120800
11	Griffrohr						85WP13	405P120900
12	Gummimuffe							401P120600
13	Schalter / Switch / Gâchette	rund / round / ronde						385P033009
14	Schalter / Switch / Gâchette	flach / flat / flat (Crouzet)						385P233009
15	Brennerkappe / Back cap / Coiffe	kurz / short / courte			L=20.5 mm		56Y45	405P120100
16	Brennerkappe / Back cap / Coiffe	lang / long / longue			L=105.5 mm		56Y44	405P120200
A	Isolator / Insulator / Isolateur			Standard			12NG	405P120300
B	Isolator / Insulator / Isolateur			Gas lens			12GLG	405P120301
C	Isolator / Insulator / Isolateur			Metallic nozzle			12MNG	405P120302
D	Isolierhülse / Insulating sleeve / Tube isolante						85Z99	405P120303

	Ø 2.4 mm Ø 3/32"	Ø 3.2 mm Ø 1/8"	Ø 4.0 mm Ø 5/32"	Ø 4.8 mm Ø 3/16"	Ø 6.4 mm Ø 1/4"
--	---------------------	--------------------	---------------------	---------------------	--------------------

Spannhülse / Collet / Pince étou

E	L=60,2 mm	85Z15 405P120502	85Z16 405P120503	85Z17 405P120504	85Z18 405P120505	85Z19 405P120506
---	-----------	---------------------	---------------------	---------------------	---------------------	---------------------

Spannhülsegehäuse / Collet body / Support collet

F	Ø 2.4-6.4 mm 11WP65, 405P121000				
---	------------------------------------	--	--	--	--

Gaslinsen / Gas lens / Diffuseur gaz

G	11GL32 405P121302	11GL18 405P121303	11GL53 405P121304	11GL36 405P121305	- 405P121306
---	----------------------	----------------------	----------------------	----------------------	-----------------

	No. 4 Ø 6.5 mm Ø 1/4"	No. 5 Ø 8.0 mm Ø 5/16"	No. 6 Ø 9.5 mm Ø 3/8"	No. 7 Ø 11 mm Ø 7/16"	No. 8 Ø 12.5 mm Ø 1/2"	No. 10 Ø 16 mm Ø 5/8"	No. 12 Ø 19 mm Ø 3/4"	Ø 24 mm
--	-----------------------------	------------------------------	-----------------------------	-----------------------------	------------------------------	-----------------------------	-----------------------------	---------

Keramische Gasdüsen / Ceramic nozzles / Buses gaz

H	Standard, L=32.0 mm	14N57 401P101700	14N58 401P101701	14N59 401P101702	14N60 401P101703	14N61 401P101704	-	-	-
J	Jumbo Gas lens L=48.0 mm	-	-	57N75 401P201451	-	57N74 401P201452	53N88 401P222250	53N87 401P222251	53N89-L 401P222253
K	Jumbo Gas lens (short), L=34.0 mm	-	-	-	-	-	-	-	53N89 401P222252

Metallische Gasdüsen / Metal nozzles / Buses gaz metal

L	Standard, L=40.7 mm	-	-	86Z01 405P120700	-	86Z02 405P120701	86Z03 405P120702	86Z06 405P120703	-
---	------------------------	---	---	---------------------	---	---------------------	---------------------	---------------------	---

▶ = Standard

Ready for Tomorrow.

© 2010 Tbi Industries GmbH. Alle Rechte vorbehalten. Technische Änderungen vorbehalten. Kopie oder Nachdruck auch auszugsweise nicht gestattet. / *All rights reserved. Subject to change without notice. Excerpts and reprints not permitted.* / *Tous droits réservés. Sous réserve de modifications techniques. Copie/reproduction même partielle non autorisée.* Nr. DOKP12101C, 03/2010.

Tbi Industries GmbH
Ruhberg 14
D-35463 Fernwald-Steinbach
Postfach 67
D-35461 Fernwald-Steinbach

Tel. + 49 6404 9171-0
Fax. + 49 6404 9171-58
Internet: www.tbi-industries.com
E-mail: info@tbi-industries.com